

ENC-A2N Single-Ended Encoder without Index Channel



FEATURES

- 32 to 1,250 Cycles Per Revolution (CPR)
- Tracks 0 to 300,000 Cycles Per Second
- 2-Channel Quadrature TTL Squarewave Outputs
- Operating Temperature of -40° to +100° C
- Powered from a Single +5VDC Power Supply
- Allows for +/- .010" Axial Shaft Play



DESCRIPTION

The ENC-A2N is single-ended encoder that requires a minimum shaft length of .445" and maximum shaft length of .575", and is compatible with shaft sizes ranging from .079" to .394" in diameter. The ENC-A2N provides digital feedback information for motion control applications that require position, speed and/or direction control. This line of encoders is RoHS and REACH Certified.

Optical Encoder Module Update:

This new transmissive optical encoder module is designed to be an improved replacement for the Avago HEDS-9000 series encoder module. This module is designed to detect rotary position when used with a code wheel. The new module consists of a lensed LED source and a monolithic detector IC enclosed in a small polymer package. The new module uses phased array detector technology to provide superior performance and greater tolerances over traditional aperture mask type encoders. Each module is resolution specific and is matched to the resolution of a code wheel. All standard resolutions offered by the HEDS-9000 series encoder module, as well as additional resolutions, are now supported by the new module. The new module operates with a single 5V supply and provides single ended outputs which are capable of both sinking and sourcing 8mA at TTL levels. An internal 0.1 uF decoupling capacitor is designed into the new module to provide enhanced noise immunity over the HEDS-9000 series encoder modules. Physically, the new module has no external wire loops which can interfere when mounting. The connector pins are 0.051" shorter than HEDS modules, while still providing .30" insertion depth.

ORDERING INFORMATION

ENC - A2N - 0050 - 394 - H - G

CPR		
0032	0250	0540
0050	0256	0720
0096	0360	0900
0100	0400	1000
0192	0500	1024
0200	0512	1250

Bore Size	
079 = 2mm	236 = 6mm
118 = 3mm	250 = 1/4"
125 = 1/8"	276 = 7mm
156 = 5/32"	313 = 5/16"
157 = 4mm	315 = 8mm
188 = 3/16"	375 = 3/8"
197 = 5mm	394 = 10mm

Cover Options
E = Cover Extension
H = Hole in Cover
Blank = Default

Base Options
3 = Base Mounting Holes Become 0.125"
A = Adds Self-Aligning Shoulder to Base
G = Adds 1.812" Mounting Ears to Base
R = Adds 3-Slot Adapter to Bottom of Base
Blank = Default

L010723

DEFAULT OPTION:

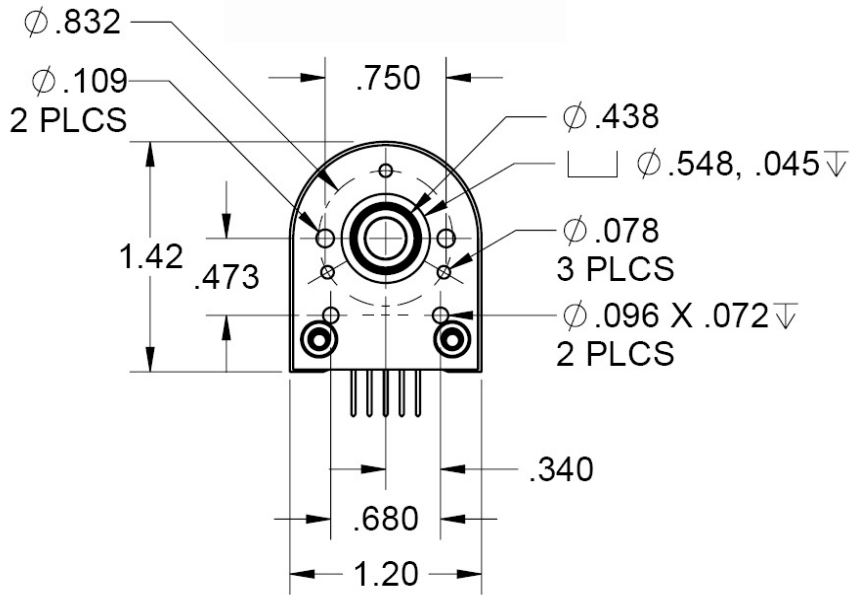

Note: All dimensions are in inches

Default Option:

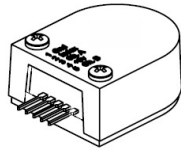

H-Option:

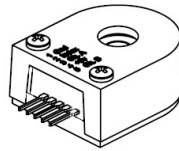

E-Option:

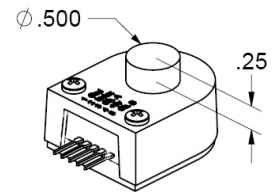

Note: Dimensions are in inches

Cover Options:	Description
E - Option	E-Option provides a cylindrical extension cover for larger shafts. The required shaft length is .445" to .795". Note: E-option + R-Option the required shaft length is .570" to .920".
H - Option	Shaft < .375" - a .375" diameter hole is used Shaft $\geq .375$ " or larger - a .500" diameter hole is used Minimum Shaft Length: greater than .445" Note: H-Option + R-Option the required shaft length is > .570"
Default	The required length is .445" to .570" Note: Default Option + R-Option the required shaft length is .570" to .695"

3-OPTION:

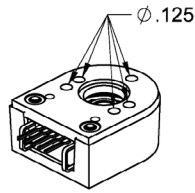

3-Option: Makes all five hole diameters .125"

G-OPTION:

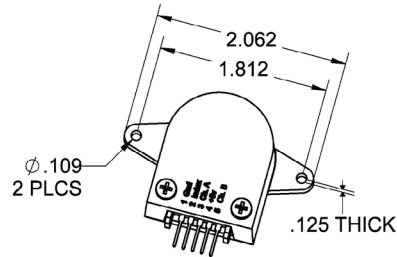

G-Option: Includes molded ears which enables it to be mounted to a 1.812" diameter bolt circle. Mounting holes are designed to fit 4-40 screws. Will work with shaft lengths of .445" to .570" and does not add to the required shaft length.

A-OPTION:

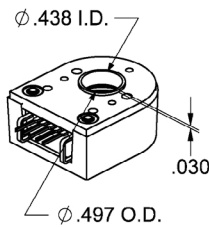

A-Option: Adds a .497" diameter alignment shoulder designed to slip into a .500" diameter recess in the mounting surface centered around the shaft.

R-OPTION:

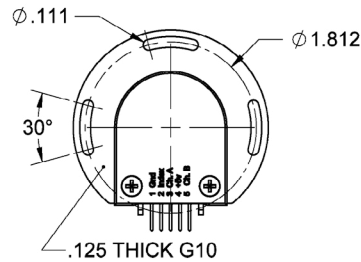

R-Option: Adapter is an 1/8" thick fiberglass adapter which is pre-mounted to the base of the encoder. It allows the encoder to rotate +/- 15 degrees. *This option adds 1/8" to the required shaft length.

Note: All dimensions are in inches

(Note: Base Mounting Screws are NOT included. #2-56 or #4-40 screws can be used to mount the base to your mounting surface.)

SINGLE-END ENCODER TIMING DIAGRAMS

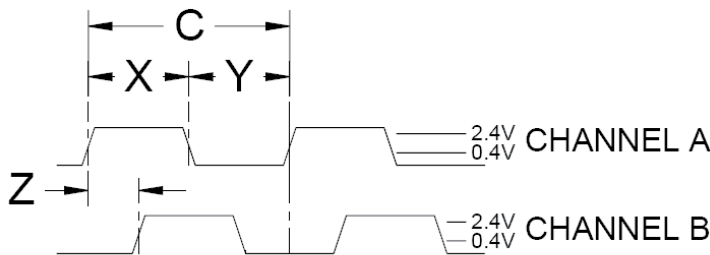

ROTATION:
CW - B LEADS A, CCW - A LEADS B

Timing Characteristics	Symbol	Min	Typ	Max	Units
Cycle Error	C	-	3.0	5.5	°e
Symmetry	X,Y	150	180	210	°e
Quadrature	Z	60	90	120	°e
Index Pulse Width	Po	60	90	120	°e
Ch. I Rise After Ch. B or Ch. A Fall	t1	10	100	250	ns
Ch. I Fall After Ch. B or Ch. A Rise	t2	70	150	300	ns

SINGLE-ENDED ENCODER PINOUT
TOP OF ENCODER FACING PLUG

Pin #	Function
1	Ground
2	No Connection
3	Channel A
4	+5VDC Input
5	Channel B

Terminology	Definition
CPR(N):	The Number of Cycles Per Revolution
One Shaft Rotation:	360 mechanical degrees, N cycles
One Electrical Degree (°e):	1/360th of one cycle
One Cycle (C):	360 electrical degrees (°e). Each cycle can be decoded into 1 or 4 codes, referred to as X1 or X4 resolution multiplication
Symmetry:	A measure of the relationship between (X) and (Y) in electrical degrees, nominally 180 °e
Quadrature (Z):	The phase lag or lead between channels A and B in electrical degrees, nominally 90 °e
Index (CH I):	The index output goes high once per revolution, coincident with the low states of channels A and B, nominally 1/4 of one cycle (90 °e)

Recommended Operating Conditions	Min	Max	Units
Temperature (CPR < 2000)	-40	100	°C
Temperature (CPR ≥ 2000)	-25	100	°C
Load Capacitance	-	100	pF
Count Frequency (CPR ≤ 1250)	-	300	kHz
Count Frequency (CPR 2000-2500)	-	360	kHz
Count Frequency (CPR 4000+)	-	720	kHz

Parameter	Max	Units
Vibration (5 to 2kHz)	20	g
Shaft Axial Play	+/- 0.01	in.
Shaft Eccentricity Plus Radial Play	0.004	in.
Acceleration	250,000	rad/sec ²

Parameter	Min	Typ	Max	Units
Supply Voltage	4.5	5.0	5.5	Volts
Supply Current				
CPR < 500, no load	-	27	30	mA
CPR ≥ 500 and < 2000, no load	-	55	57	mA
CPR ≥ 2000, no load	-	72	85	mA
Low-Level Output				
I _{OL} = 8mA max (CPR < 2000)	-	-	0.5	V
I _{OL} = 5mA max (CPR ≥ 2000)	-	-	0.5	V
no load (CPR ≥ 2000)	-	0.25	-	V
High-Level Output				
I _{OL} = 8mA max (CPR < 2000)	2.0	-	-	V
I _{OL} = 5mA max (CPR ≥ 2000)	2.0	-	-	V
no load (CPR < 2000)	-	4.8	-	V
no load (CPR ≥ 2000)	-	3.5	-	V
Output Current Per Channel (CPR < 2000)	-8.0	-	8.0	mA
Output Current Per Channel (CPR ≥ 2000)	-5	-	5	mA
Output Rise Time (CPR < 2000)	-	110	-	nS
Output Rise Time (CPR ≥ 2000)	-	50	-	nS
Output Fall Time (CPR < 2000)	-	100	-	nS
Output Fall Time (CPR ≥ 2000)	-	50	-	nS

* Unloaded high level output voltage is 4.80V typically, 4.2V minimum.

Speed Calculation		Units
CPR ≤ 1250	18x10 ⁶ / CPR	RPM
CPR 2000-2500	21.6x10 ⁶ / CPR	RPM
CPR 4000+	43.2x10 ⁶ / CPR	RPM

*60,000 RPM is the maximum RPM due to mechanical limitations.

Cables:

The following cables are compatible with Anaheim Automation's A2N series encoder. Select a cable length from the table below:

Cable Part Number	Length
ENC-CBL-AA4175	1 ft.
ENC-CBL-AA4175-02	2 ft.
ENC-CBL-AA4175-05	5 ft.
ENC-CBL-AA4175-10	10 ft.

NOTE: For pricing and other information on cables and centering tools, please visit Accessories on our website.

Centering Tools:

Centering tools are optional, but recommended for a more precise installation.

ENC-CTOOL - 250

Bore Size	
079=2mm	236=6mm
118=3mm	250=1/4"
125=1/8"	276=7mm
157=4mm	313=5/15"
188=3/16"	375=3/8"
197=5mm	394=10mm